

Reactor[®] 2 App

For Reactor 2 Integrated Systems

3A5539C

EN

For remotely changing system settings on Graco Reactor 2 E-30i and E-XP2i systems. For professional use only.



Important Safety Instructions

Read all warnings and instructions in this manual and in the Reactor[®] 2 manual. Save all instructions.

IMPORTANT

By operating your Reactor 2 system with the cellular module installed, you are accepting the Graco Reactor App Terms and Conditions and Software License Agreement (“Terms”).

To review the Terms, install the Reactor App on your mobile device or visit www.graco.com.

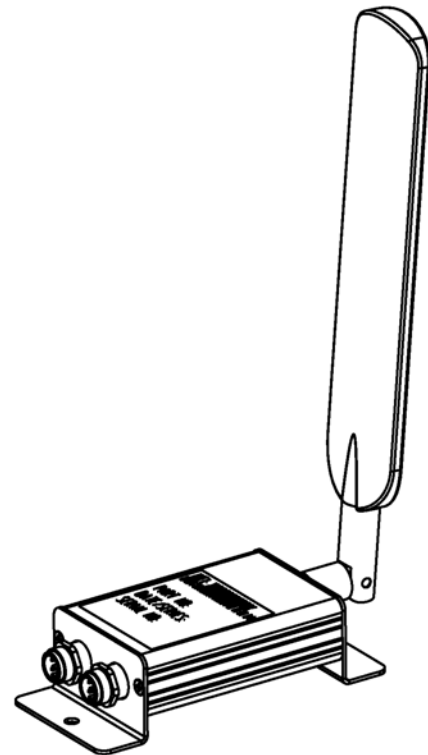

Contents

Related Manuals	2	Cellular Screen	8
Agency Approvals	2	View Cellular Screen	8
Warnings	3	Reset Reactor Key	8
Typical Installation	4	Troubleshooting	9
Overview	5	Disconnect Cellular Module	9
Installation	5	Parts	10
Mount Cellular Module	5	Cellular Module and Antenna	10
Setup	6	Accessory Antenna	10
Connect App to Reactor	6	Technical Specifications	11
Operation	7	Graco Standard Warranty	12
Reactor 2 App	7		

Related Manuals

Manual	Description
332636	Reactor 2 Elite Integrated Proportioning System (Operation)
332637	Reactor 2 Elite Integrated Proportioning System (Repair-Parts)





Agency Approvals

NOTE: Cellular module kit 25M833 contains Part 25M720.

Description	Approvals
MODULE, cellular (25M720)	

Warnings

The following warnings are for the setup, use, grounding, maintenance, and repair of this equipment. The exclamation point symbol alerts you to a general warning and the hazard symbols refer to procedure-specific risks. When these symbols appear in the body of this manual or on warning labels, refer back to these Warnings. Product-specific hazard symbols and warnings not covered in this section may appear throughout the body of this manual where applicable.

 <h2 style="margin: 0;">WARNING</h2>	
	<p>ELECTRIC SHOCK HAZARD</p> <p>This equipment must be grounded. Improper grounding, setup, or usage of the system can cause electric shock.</p> <ul style="list-style-type: none"> • Turn off and disconnect power at main switch before disconnecting any cables and before servicing or installing equipment. • Connect only to grounded power source. • All electrical wiring must be done by a qualified electrician and comply with all local codes and regulations.
	<p>EQUIPMENT MISUSE HAZARD</p> <p>Misuse can cause death or serious injury.</p> <ul style="list-style-type: none"> • Do not operate the unit when fatigued or under the influence of drugs or alcohol. • Do not exceed the maximum working pressure or temperature rating of the lowest rated system component. See Technical Specifications in all equipment manuals. • Use fluids and solvents that are compatible with equipment wetted parts. See Technical Specifications in all equipment manuals. Read fluid and solvent manufacturer's warnings. For complete information about your material, request Safety Data Sheets (SDSs) from distributor or retailer. • Do not leave the work area while equipment is energized or under pressure. • Turn off all equipment and follow the Pressure Relief Procedure when equipment is not in use. • Check equipment daily. Repair or replace worn or damaged parts immediately with genuine manufacturer's replacement parts only. • Do not alter or modify equipment. Alterations or modifications may void agency approvals and create safety hazards. • Make sure all equipment is rated and approved for the environment in which you are using it. • Use equipment only for its intended purpose. Call your distributor for information. • Route hoses and cables away from traffic areas, sharp edges, moving parts, and hot surfaces. • Do not kink or over bend hoses or use hoses to pull equipment. • Keep children and animals away from work area. • Comply with all applicable safety regulations.
	<p>MOVING PARTS HAZARD</p> <p>Moving parts can pinch, cut or amputate fingers and other body parts.</p> <ul style="list-style-type: none"> • Keep clear of moving parts. • Do not operate equipment with protective guards or covers removed. • Pressurized equipment can start without warning. Before checking, moving, or servicing equipment, follow the Pressure Relief Procedure and disconnect all power sources.

Typical Installation

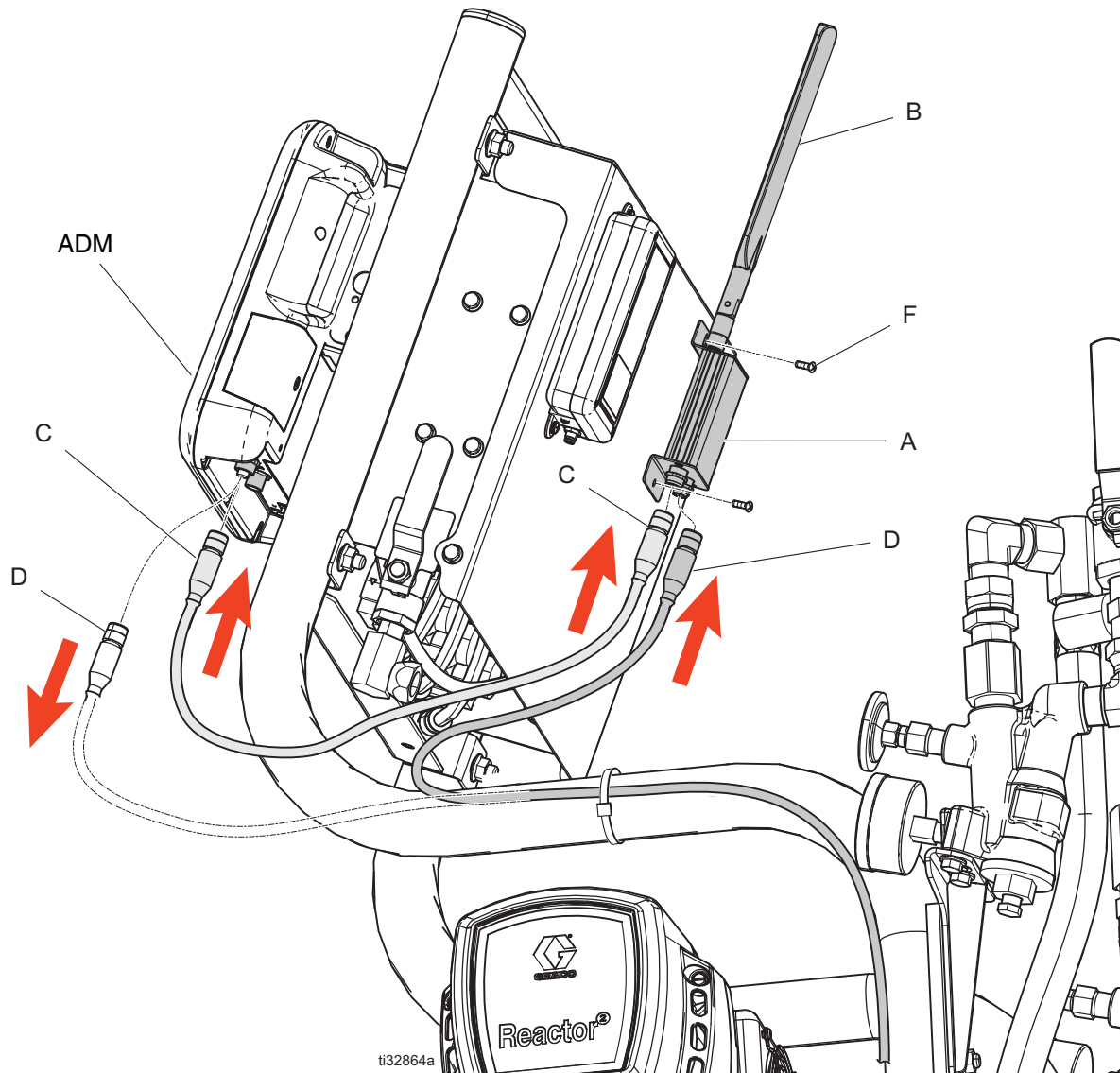





FIG. 1: Typical Reactor App Cell Module Installation

Ref.	Description
A	Cellular Module
ADM*	Advanced Display Module
B	Antenna

Ref.	Description
C	CAN Cable
D*	ADM Cable
F	Control Panel Screws

* Included with Reactor 2 proportioner.

Overview

				
<p>To avoid injury due to unexpected machine operation initiated by remote controller, disconnect the cellular module from the system prior to troubleshooting. See Disconnect Cellular Module, page 9.</p>				

The Reactor 2 App allows the Graco Reactor 2 to be monitored and operated remotely. The Reactor 2 is intended to be controlled by an on-site operator. In any lock-out, tag-out procedure, take into consideration the potential for changes to the Reactor 2 settings due to remote operation.

Installation

Mount Cellular Module





1. Shut down the system. See your Reactor 2 operation manual for shutdown instructions.
2. Disconnect incoming power at the source.
3. Install the cellular module (A) onto the back of the proportioner control panel. Use two screws (F) to mount the module onto the holes in the control panel.
4. Disconnect the ADM cable (D) from the ADM. Hand tighten the loose end of the ADM cable to the mounted cellular module (A).
5. Connect the CAN cable (C) to the cellular module (A) and the ADM.
6. Install the antenna (B) to the cellular module (A). Tighten by hand.

Setup

Download the Graco Reactor app on the Apple App Store® or the Android Google Play™ store.

1. Open the Reactor App on your smartphone.
2. Read and accept the Terms of Use and data usage notification.
3. Enter your contact information and review the app tutorial.

Connect App to Reactor

1. On the Reactor ADM, press  to enter the setup mode.
2. Press  to go to the Cellular screen (see FIG. 3).

NOTE: Before connecting the Reactor to an app for the first time, **Reset Reactor Key**. See page 8.

3. To connect the app to the Reactor, scan the code.
 - a. Select the Scan code button on the app. (See FIG. 2.)
 - b. Using the app and your smartphone camera, scan the code displayed on the ADM Cellular screen.
4. If you have trouble scanning the code, type in the IMEI and the key instead.
 - a. Select Type in IMEI and key. (See FIG. 2.)
 - b. Enter the Reactor IMEI found on the ADM Cellular screen.
 - c. Enter the Reactor key found on the ADM Cellular screen.
 - d. Select the Connect button on the app.

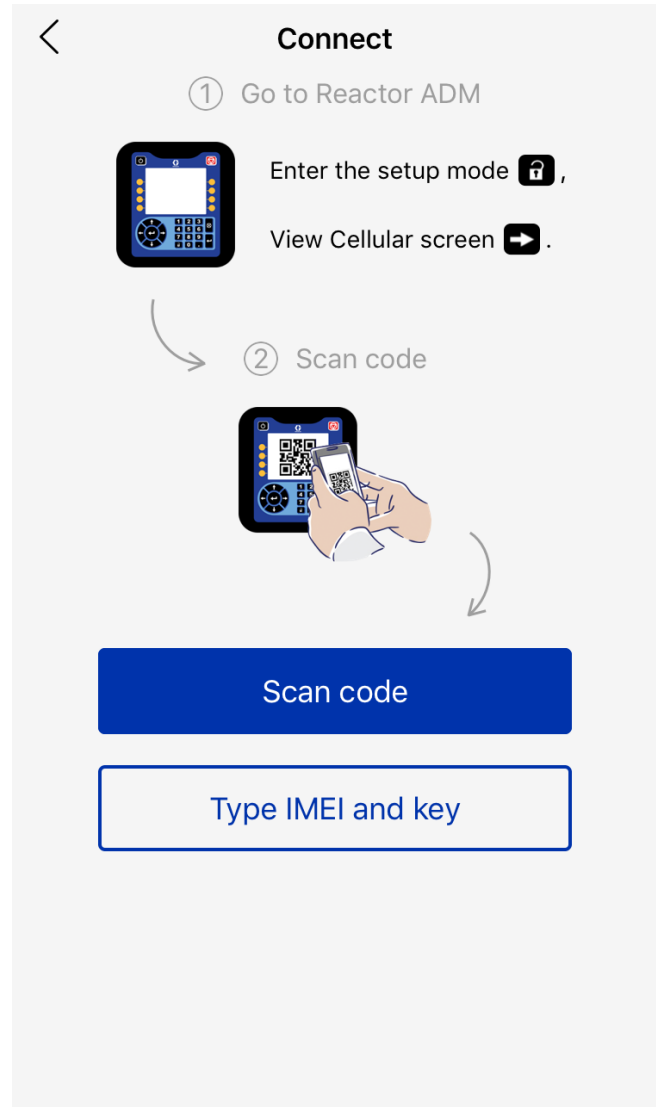
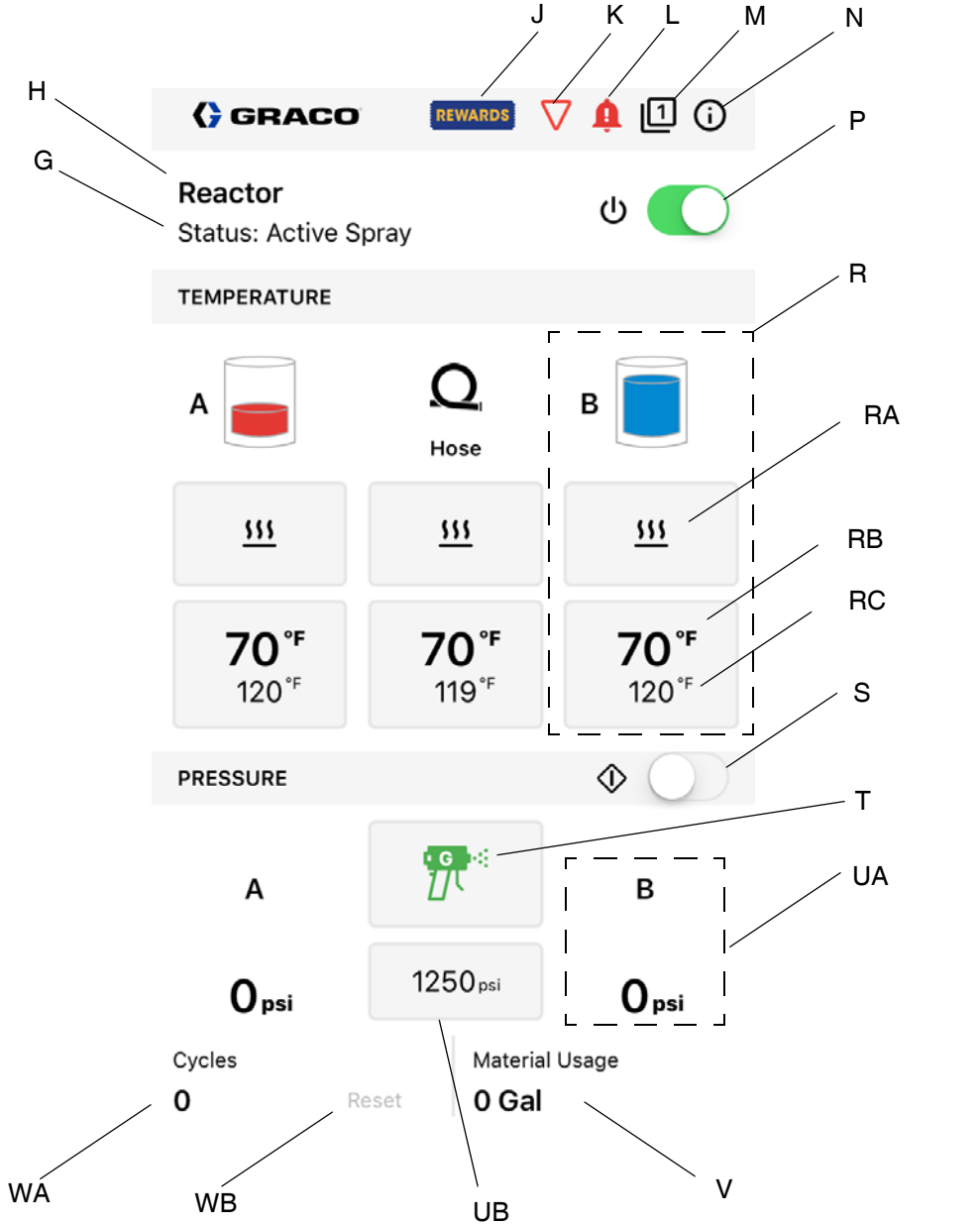

FIG. 2: Connect Screen in App

Operation

Reactor 2 App



Ref.	Description
G	Reactor Status
H	Reactor Name
J	Graco Rewards Website
K	Yield Calculator
L	Alarm Screen
M	Connected Reactors
N	Application Information
P	Reactor Power Switch
R	Heat Zone Settings
RA	Heat Zone On/Off

Ref.	Description
RB	Heat Zone Actual Temperature
RC	Heat Zone Temperature Setpoint
S	Proportioner Start/Stop Switch
T	Proportioner Mode (Spray, Jog, Park)
UA	Pump Pressure
UB	Pump Pressure Setpoint
V	Material Usage
WA	Cycle Count
WB	Reset Cycle Count



Cellular Screen



FIG. 3: ADM Cellular Screen



Use this screen to connect the Reactor 2 app to the Reactor, determine the cellular signal strength, or reset the Reactor Key.

View Cellular Screen

1. On the Reactor ADM, press  to enter the setup mode.
2. Press  to go to the Cellular screen.

Reset Reactor Key

Resetting your Reactor Key prevents other users from remotely changing or viewing Reactor settings without first reconnecting to the Reactor.

1. On the Reactor ADM Cellular screen, press  to reset the Reactor key.
2. Press  to confirm resetting the Reactor key.
3. Reconnect your app to the Reactor. See **Connect App to Reactor**, page 6.

NOTE: After resetting your Reactor key, all operators using the Graco Reactor 2 app must reconnect to the Reactor.

NOTE: For security of wireless control, change the Reactor key on a regular basis and whenever there is a concern about unauthorized access.

Troubleshooting



For information on troubleshooting a Reactor, refer to the Reactor repair manual.

Disconnect Cellular Module

NOTE: Before troubleshooting the Reactor, disconnect the cellular module (A) from the ADM. The Reactor 2 App cannot change Reactor 2 settings while the cellular module is disconnected.

1. Shut down system. See your Reactor 2 operation manual for shutdown instructions.
2. Disconnect incoming power at the source.
3. Disconnect the CAN cable (C) from the cellular module (A) and ADM.
4. Disconnect the ADM cable (D) from the cellular module (A). Reconnect the loose end of the ADM cable to the ADM.

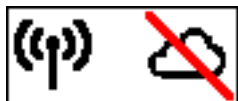
Problem	Cause	Solution
No module status LEDs are illuminated.	No power to cellular module.	Turn Reactor proportioner on. Ensure cellular module is properly installed. See Overview , page 5.
No network connection. 	Still establishing cellular connection.	Wait a few minutes for the unit to establish a connection.
	Unable to establish cellular connection.	To establish cellular connection, move system to a location with cellular service. Mount accessory antenna 25D878 on the outside of your trailer.
Network is connected, but there is no server connection. 	Cellular module software is incorrect.	Go to ADM Advanced Software screen and confirm that software is correct. If it is not, update the ADM software.
	Server is not responding.	Wait a few minutes for the unit to establish a connection.

Parts

Cellular Module and Antenna

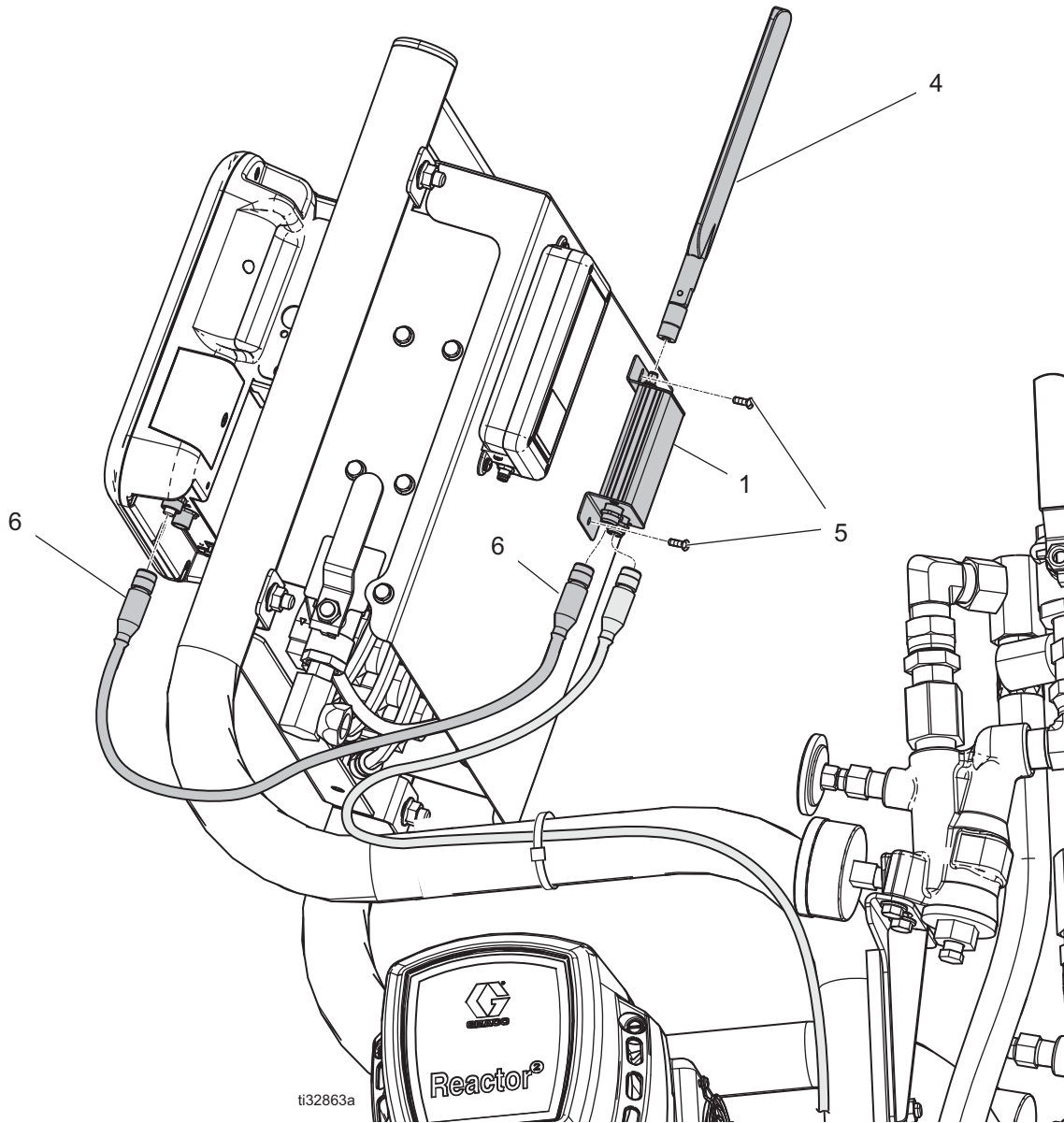

Ref.	Part	Description	Qty.
1	25M833	MODULE, cellular	1
4	25M828	ANTENNA, paddle	1
5	16X129	SCREW, phillips, 8-32, 3/2 long	2
6	121002	CABLE, can	1

Accessory Antenna

Part	Description	Qty.
25D878	ANTENNA, external use (not shown)	1

Technical Specifications

Reactor 2 App	
FCC/IC	
Contains FCC ID	XPY1CGM5NNN
Contains IC ID (Industry Canada)	8595A-1CGM5NNN
<p>The enclosed device complies with Part 15 of the FCC Rules and with Industry Canada licence-exempt RSS standard(s). Operation is subject to the following two conditions:(1) this device may not cause harmful interference and (2) this device must accept any interference received, including interference that may cause undesired operation.</p> <p><i>Le présent appareil est conforme aux CNR d'Industrie Canada applicables aux appareils radio exempts de licence. L'exploitation est autorisée aux deux conditions suivantes : (1) l'appareil ne doit pas produire de brouillage, et (2) l'utilisateur de l'appareil doit accepter tout brouillage radioélectrique subi, même si le brouillage est susceptible d'en compromettre le fonctionnement.</i></p> <p>Changes or modifications not expressly approved by the party responsible for compliance could void the user's authority to operate the equipment.</p>	
Cellular Radio Data	
Cellular Radio	u-blox SARA-U201
Band Support	Band 19 (800 MHz) Band 5 (850 MHz) Band 8 (900 MHz) Band 2 (1900 MHz) Band 1 (2100 MHz)
WCDMA/HSDPA/HSUPA Power Class	Power Class 3 (24 dBm) for WCDMA/HSDPA/HSUPA mode

Graco Standard Warranty

Graco warrants all equipment referenced in this document which is manufactured by Graco and bearing its name to be free from defects in material and workmanship on the date of sale to the original purchaser for use. With the exception of any special, extended, or limited warranty published by Graco, Graco will, for a period of twelve months from the date of sale, repair or replace any part of the equipment determined by Graco to be defective. This warranty applies only when the equipment is installed, operated and maintained in accordance with Graco's written recommendations.

This warranty does not cover, and Graco shall not be liable for general wear and tear, or any malfunction, damage or wear caused by faulty installation, misapplication, abrasion, corrosion, inadequate or improper maintenance, negligence, accident, tampering, or substitution of non-Graco component parts. Nor shall Graco be liable for malfunction, damage or wear caused by the incompatibility of Graco equipment with structures, accessories, equipment or materials not supplied by Graco, or the improper design, manufacture, installation, operation or maintenance of structures, accessories, equipment or materials not supplied by Graco.

This warranty is conditioned upon the prepaid return of the equipment claimed to be defective to an authorized Graco distributor for verification of the claimed defect. If the claimed defect is verified, Graco will repair or replace free of charge any defective parts. The equipment will be returned to the original purchaser transportation prepaid. If inspection of the equipment does not disclose any defect in material or workmanship, repairs will be made at a reasonable charge, which charges may include the costs of parts, labor, and transportation.

THIS WARRANTY IS EXCLUSIVE, AND IS IN LIEU OF ANY OTHER WARRANTIES, EXPRESS OR IMPLIED, INCLUDING BUT NOT LIMITED TO WARRANTY OF MERCHANTABILITY OR WARRANTY OF FITNESS FOR A PARTICULAR PURPOSE.

Graco's sole obligation and buyer's sole remedy for any breach of warranty shall be as set forth above. The buyer agrees that no other remedy (including, but not limited to, incidental or consequential damages for lost profits, lost sales, injury to person or property, or any other incidental or consequential loss) shall be available. Any action for breach of warranty must be brought within two (2) years of the date of sale.

GRACO MAKES NO WARRANTY, AND DISCLAIMS ALL IMPLIED WARRANTIES OF MERCHANTABILITY AND FITNESS FOR A PARTICULAR PURPOSE, IN CONNECTION WITH ACCESSORIES, EQUIPMENT, MATERIALS OR COMPONENTS SOLD BUT NOT MANUFACTURED BY GRACO. These items sold, but not manufactured by Graco (such as electric motors, switches, hose, etc.), are subject to the warranty, if any, of their manufacturer. Graco will provide purchaser with reasonable assistance in making any claim for breach of these warranties.

In no event will Graco be liable for indirect, incidental, special or consequential damages resulting from Graco supplying equipment hereunder, or the furnishing, performance, or use of any products or other goods sold hereto, whether due to a breach of contract, breach of warranty, the negligence of Graco, or otherwise.

FOR GRACO CANADA CUSTOMERS

The Parties acknowledge that they have required that the present document, as well as all documents, notices and legal proceedings entered into, given or instituted pursuant hereto or relating directly or indirectly hereto, be drawn up in English. Les parties reconnaissent avoir convenu que la rédaction du présente document sera en Anglais, ainsi que tous documents, avis et procédures judiciaires exécutés, donnés ou intentés, à la suite de ou en rapport, directement ou indirectement, avec les procédures concernées.

Graco Information

For the latest information about Graco products, visit www.graco.com.

For patent information, see www.graco.com/patents.

TO PLACE AN ORDER, contact your Graco distributor or call to identify the nearest distributor.
Phone: 612-623-6921 or **Toll Free:** 1-800-328-0211 **Fax:** 612-378-3505

*All written and visual data contained in this document reflects the latest product information available at the time of publication.
Graco reserves the right to make changes at any time without notice.*

Original instructions. This manual contains English. MM 3A5539

Graco Headquarters: Minneapolis

International Offices: Belgium, China, Japan, Korea

GRACO INC. AND SUBSIDIARIES • P.O. BOX 1441 • MINNEAPOLIS MN 55440-1441 • USA
Copyright 2016, Graco Inc. All Graco manufacturing locations are registered to ISO 9001.

www.graco.com
3A5539 C, May 2018